

Thermally-Enhanced High Power RF LDMOS FET 30 W, 2110 – 2170 MHz

Description

The PTFA210301E is a thermally-enhanced, 30-watt, internally matched *GOLDMOS* FET intended for WCDMA applications. It is optimized for single- and two-carrier WCDMA operation from 2110 to 2170 MHz. Thermally-enhanced packaging provides the coolest operation available. Full gold metallization ensures excellent device lifetime and reliability.

PTFA210301E
Package H-30265-2

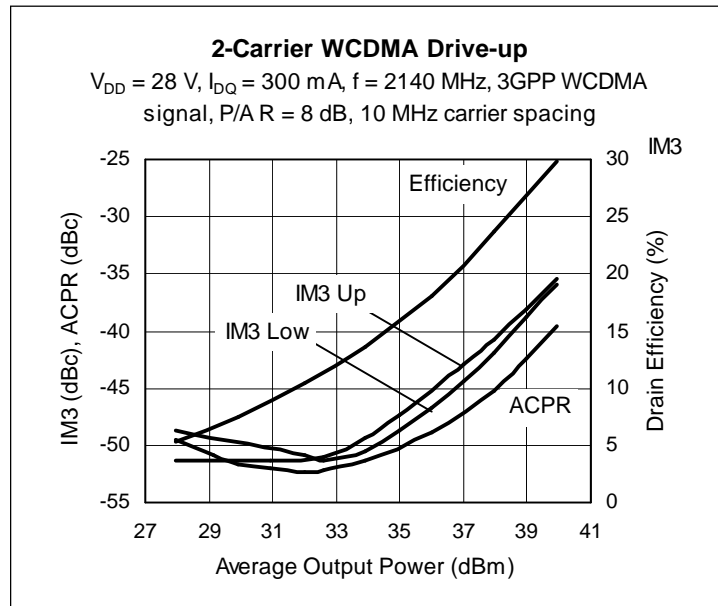
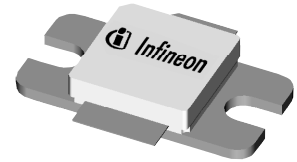

Features

- Thermally-enhanced packaging, Pb-free and RoHS-compliant
- Broadband internal matching
- Typical two-carrier WCDMA performance at 2140 MHz, 28 V
 - Average output power = 33 dBm
 - Linear Gain = 16.5 dB
 - Intermodulation distortion = -50 dBc
 - Adjacent channel power = -52 dBc
- Typical CW performance, 2170 MHz, 28 V
 - Output power at P-1dB = 40 W
 - Efficiency = 59%
- Integrated ESD protection: Human Body Model, Class 2 (minimum)
- Excellent thermal stability, low HCI drift
- Capable of handling 10:1 VSWR @ 28 V, 30 W (CW) output power

RF Characteristics

2-Carrier WCDMA Measurements (not subject to production test—verified by design/characterization in Infineon test fixture)

$V_{DD} = 28\text{ V}$, $I_{DQ} = 300\text{ mA}$, $P_{OUT} = 8\text{ W}$ average

$f_1 = 2135\text{ MHz}$, $f_2 = 2145\text{ MHz}$, 3GPP signal, channel bandwidth = 3.84 MHz, peak/average = 8 dB @ 0.01% CCDF

Characteristic	Symbol	Min	Typ	Max	Unit
Gain	G_{ps}	—	17	—	dB
Drain Efficiency	η_D	—	27	—	%
Intermodulation Distortion	IMD	—	-38	—	dBc

All published data at $T_{CASE} = 25^\circ\text{C}$ unless otherwise indicated

ESD: Electrostatic discharge sensitive device—observe handling precautions!

RF Characteristics (cont.)
Two-Tone Measurements (tested in Infineon test fixture)

 $V_{DD} = 28\text{ V}$, $I_{DQ} = 300\text{ mA}$, $P_{OUT} = 30\text{ W PEP}$, $f = 2170\text{ MHz}$, tone spacing = 1 MHz

Characteristic	Symbol	Min	Typ	Max	Unit
Gain	G_{ps}	16	17	—	dB
Drain Efficiency	η_D	34	36	—	%
Intermodulation Distortion	IMD	—	-32	-30	dBc

DC Characteristics

Characteristic	Conditions	Symbol	Min	Typ	Max	Unit
Drain-Source Breakdown Voltage	$V_{GS} = 0\text{ V}$, $I_{DS} = 10\text{ }\mu\text{A}$	$V_{(BR)DSS}$	65	—	—	V
Drain Leakage Current	$V_{DS} = 28\text{ V}$, $V_{GS} = 0\text{ V}$	I_{DSS}	—	—	1.0	μA
	$V_{DS} = 63\text{ V}$, $V_{GS} = 0\text{ V}$	I_{DSS}	—	—	10.0	μA
On-State Resistance	$V_{GS} = 10\text{ V}$, $V_{DS} = 0.1\text{ V}$	$R_{DS(on)}$	—	0.23	—	Ω
Operating Gate Voltage	$V_{DS} = 28\text{ V}$, $I_{DQ} = 300\text{ mA}$	V_{GS}	2.0	2.5	3.0	V
Gate Leakage Current	$V_{GS} = 10\text{ V}$, $V_{DS} = 0\text{ V}$	I_{GSS}	—	—	1.0	μA

Maximum Ratings

Parameter	Symbol	Value	Unit
Drain-Source Voltage	V_{DSS}	65	V
Gate-Source Voltage	V_{GS}	-0.5 to +12	V
Junction Temperature	T_J	200	$^{\circ}\text{C}$
Total Device Dissipation	P_D	145	W
		Above 25 $^{\circ}\text{C}$ derate by	0.83
Storage Temperature Range	T_{STG}	-40 to +150	$^{\circ}\text{C}$
Thermal Resistance ($T_{CASE} = 70^{\circ}\text{C}$, 30 W CW)	$R_{\theta JC}$	1.2	$^{\circ}\text{C}/\text{W}$

Ordering Information

Type and Version	Package Outline	Package Description	Marking
PTFA210301E V1	H-30265-2	Thermally-enhanced slotted flange, single-ended	PTFA210301E

Typical Performance (data taken in a production test fixture)

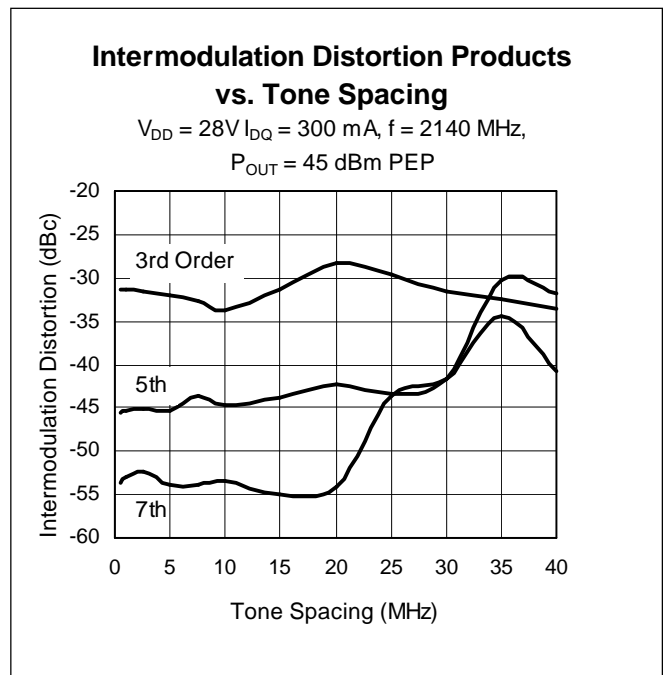
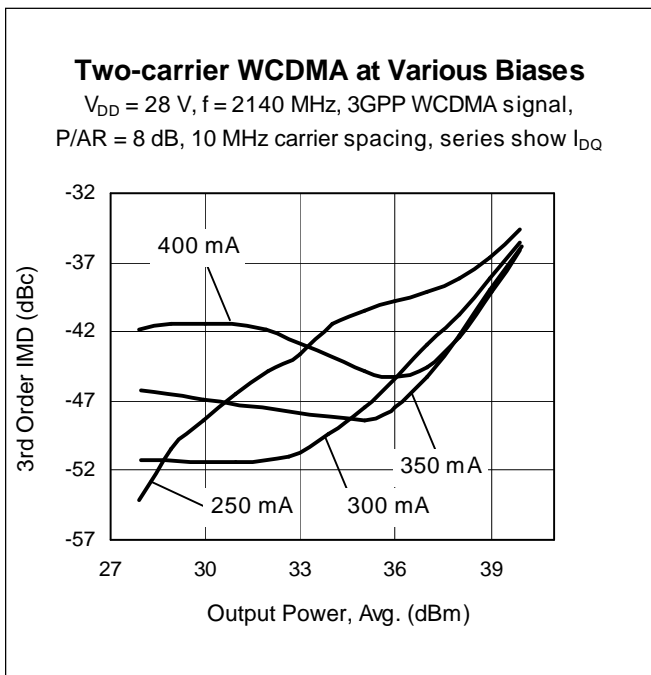
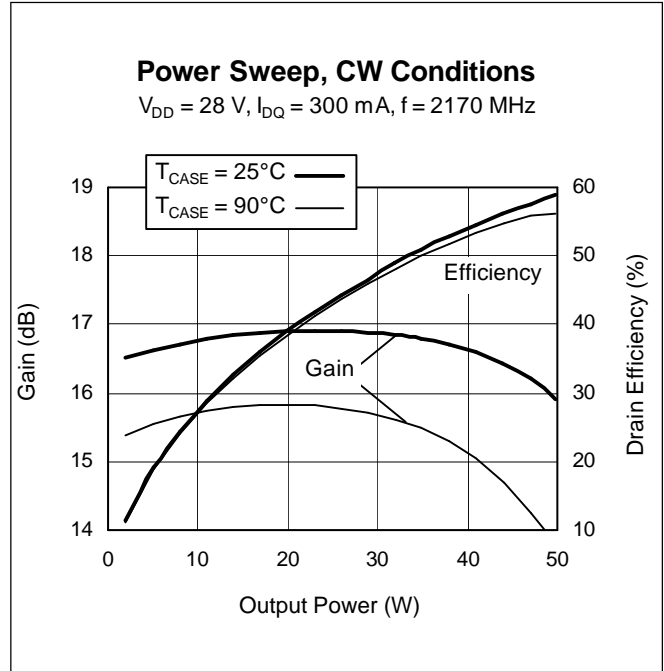
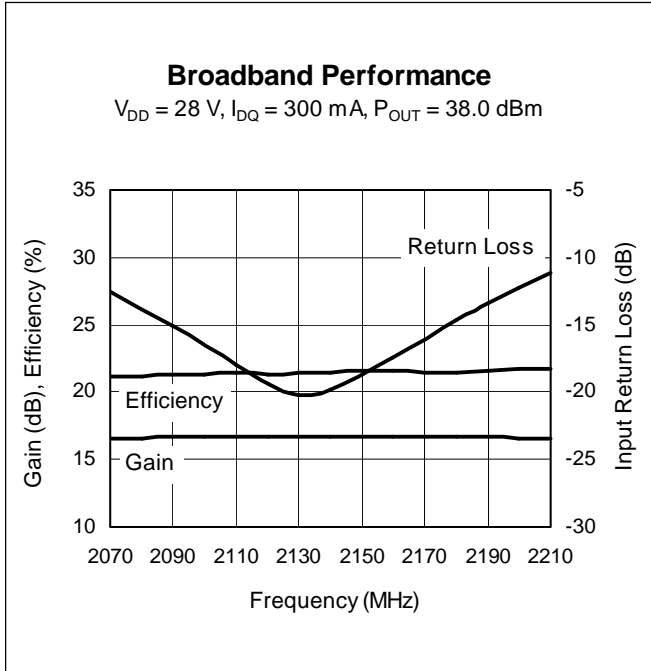

Typical Performance (cont.)

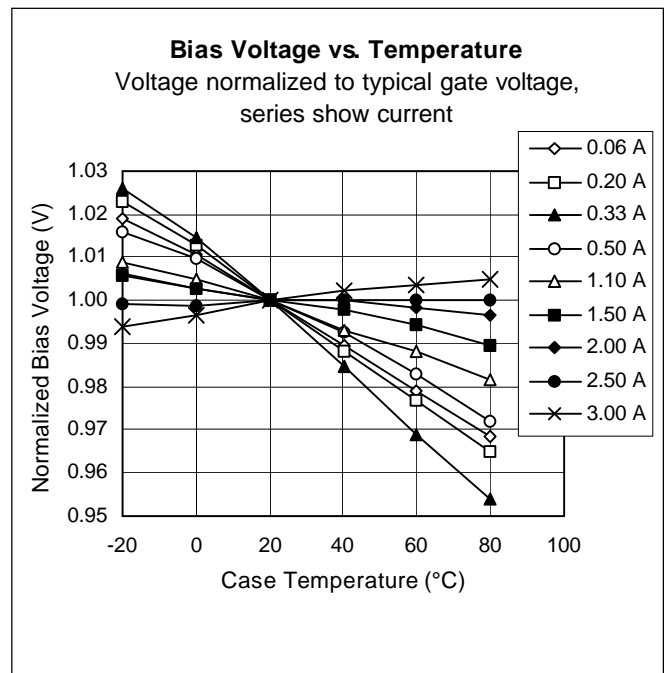
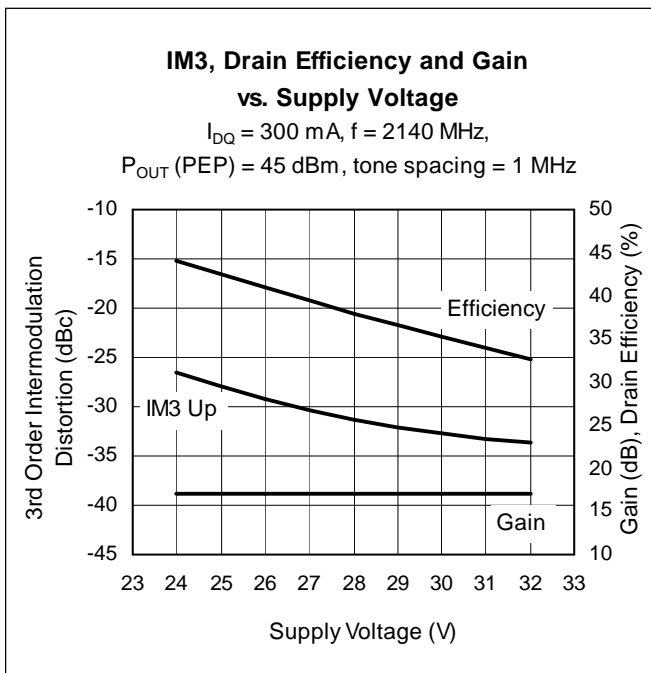
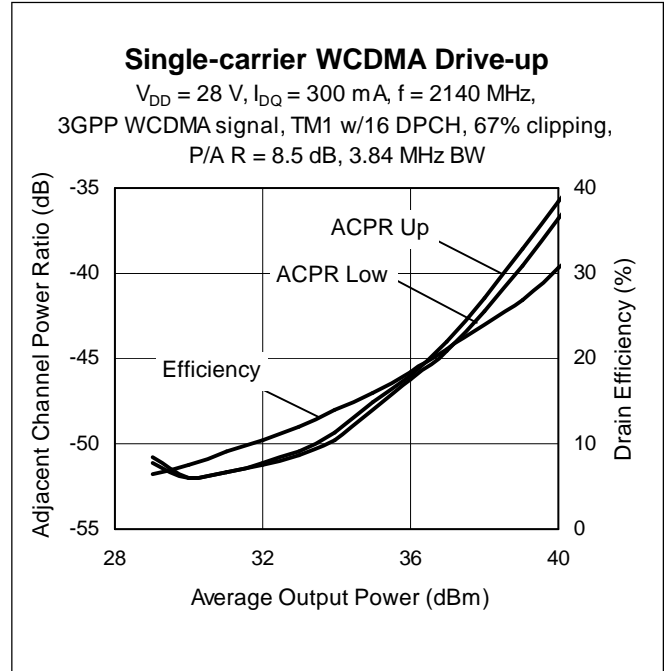
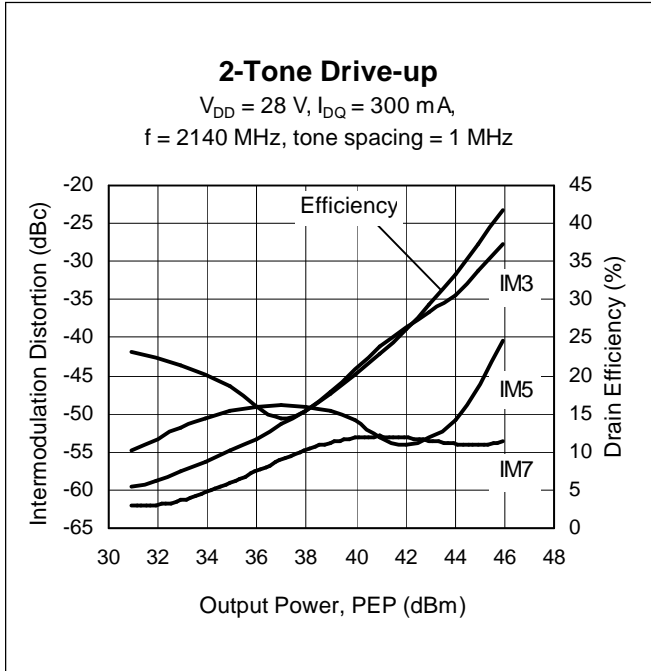

Broadband Circuit Impedance

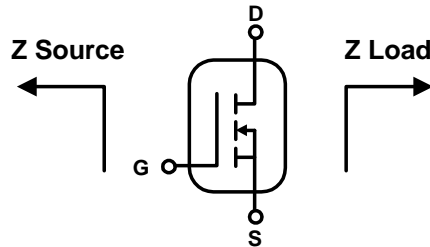

Frequency MHz	Z Source W		Z Load W	
	R	jX	R	jX
2070	14.70	-9.41	7.26	-3.82
2110	14.33	-9.52	7.01	-3.70
2140	14.07	-9.61	6.91	-3.69
2170	13.81	-9.69	6.77	-3.53
2210	13.40	-9.79	6.52	-3.39

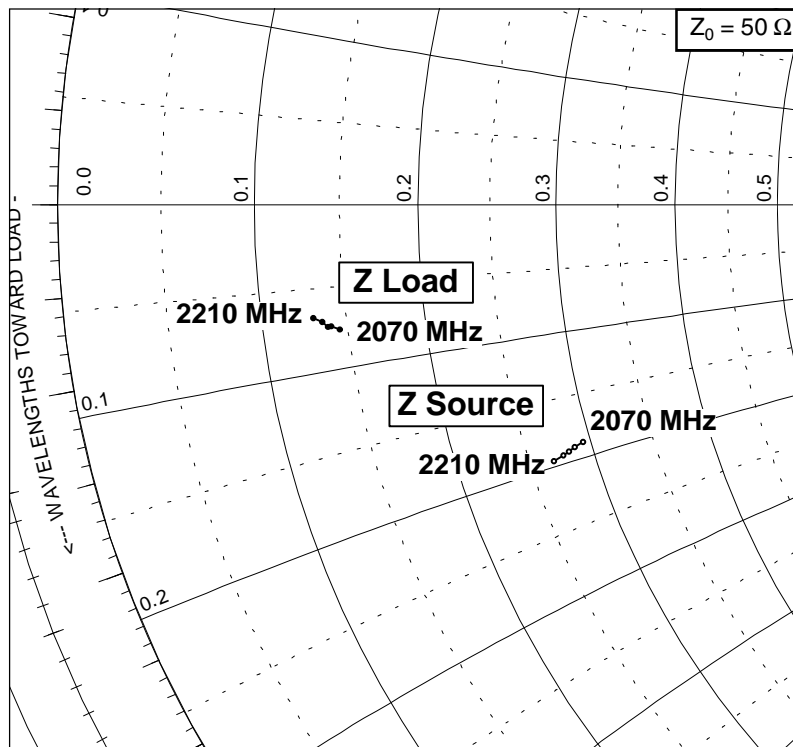

Reference Circuit

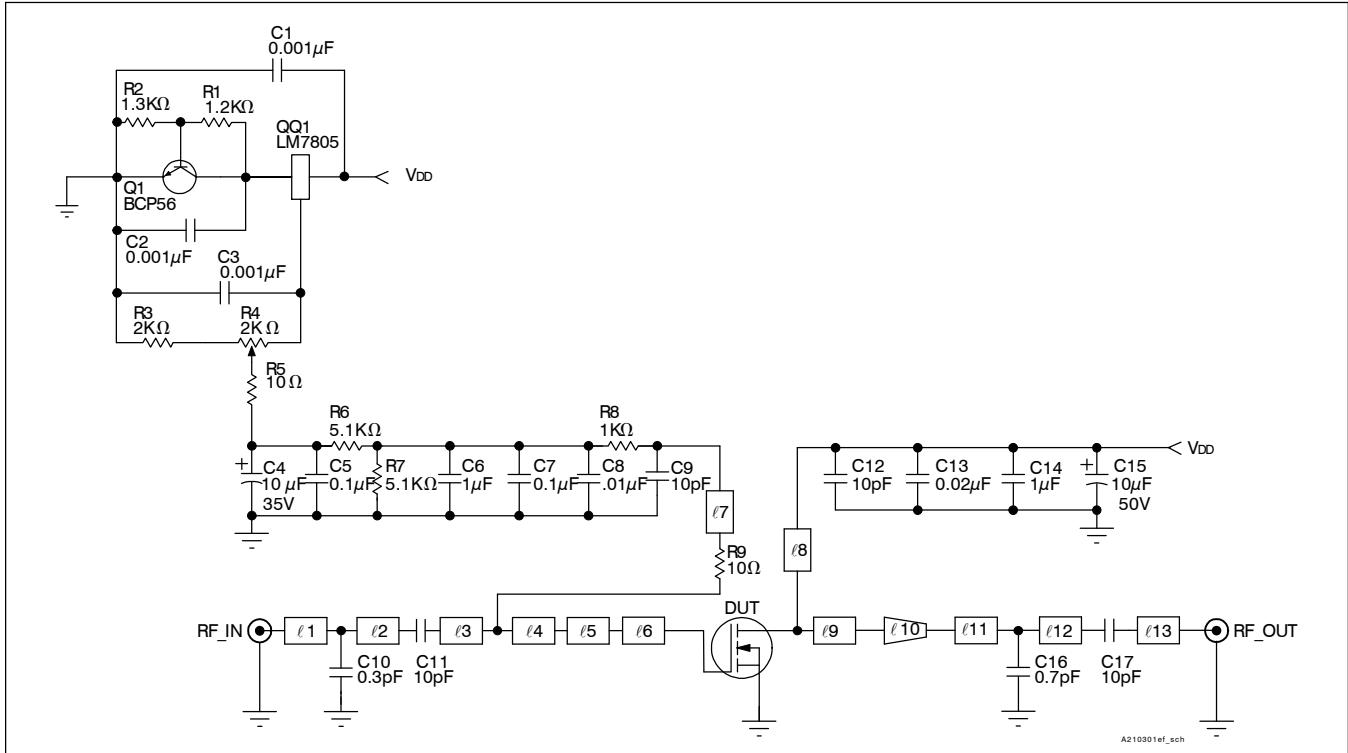

Reference Circuit Schematic for $f = 2140 \text{ MHz}$

Circuit Assembly Information

DUT	PTFA210301E	LDMOS Transistor	
PCB	0.76 mm [.030"] thick, $\epsilon_r = 4.5$	Rogers TMM4	2 oz. copper

Microstrip	Electrical Characteristics at 2140 MHz ¹	Dimensions: L x W (mm)	Dimensions: L x W (in.)
l_1	0.013 λ , 50.0 Ω	1.02 x 1.42	0.040 x 0.056
l_2	0.081 λ , 50.0 Ω	6.17 x 1.42	0.243 x 0.056
l_3	0.108 λ , 42.0 Ω	8.23 x 1.85	0.324 x 0.073
l_4	0.172 λ , 61.0 Ω	13.39 x 0.94	0.527 x 0.037
l_5	0.013 λ , 42.0 Ω	0.94 x 1.85	0.037 x 0.073
l_6	0.023 λ , 15.0 Ω	1.63 x 7.57	0.064 x 0.298
l_7	0.063 λ , 9.9 Ω	4.29 x 12.07	0.169 x 0.475
l_8	0.171 λ , 53.0 Ω	13.13 x 1.22	0.517 x 0.048
l_9	0.039 λ , 6.5 Ω	2.64 x 19.10	0.104 x 0.752
l_{10} (taper)	0.185 λ , 6.5 Ω / 50.0 Ω	4.70 x 19.10 / 1.37	0.185 x 0.752 / 0.054
l_{11}	0.025 λ , 50.0 Ω	1.88 x 1.42	0.074 x 0.056
l_{12}	0.128 λ , 50.0 Ω	9.78 x 1.42	0.385 x 0.056
l_{13}	0.057 λ , 50.0 Ω	4.32 x 1.42	0.170 x 0.056

¹Electrical characteristics are rounded.

Reference Circuit (cont.)

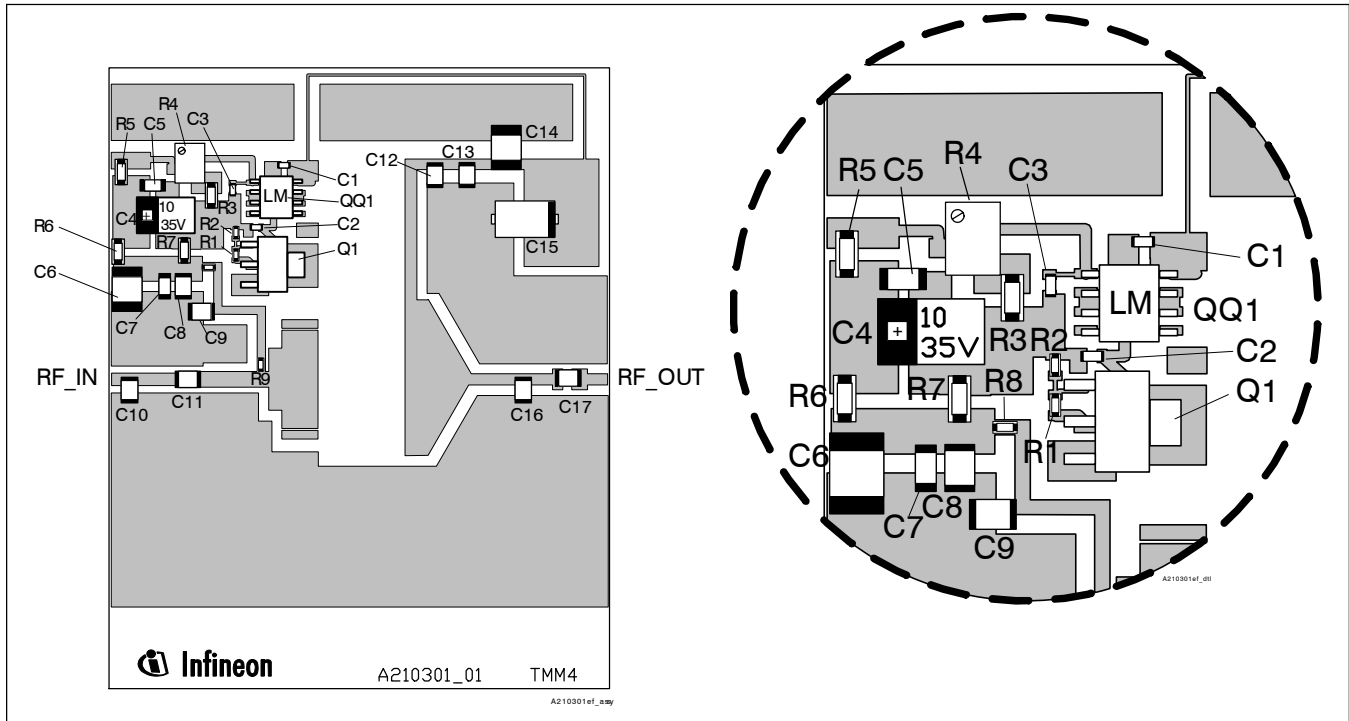

Reference Circuit* (not to scale)

Component	Description	Suggested Manufacturer	P/N or Comment
C1, C2, C3	Capacitor, 0.001 μ F	Digi-Key	PCC1772CT-ND
C4	Tantalum capacitor, 10 μ F, 35 V	Digi-Key	PCS6106TR-ND
C5, C7	Capacitor, 0.1 μ F	Digi-Key	P4525-ND
C6, C14	Capacitor, 1 μ F	Digi-Key	PCC104BCT-ND
C8	Capacitor, 0.01 μ F	ATC	100B 103
C9, C11, C12, C17	Capacitor, 10 pF	ATC	100B 100
C10	Capacitor, 0.3 pF	ATC	100B 0R3
C13	Capacitor, 0.02 μ F	ATC	100B 203
C15	Tantalum capacitor, 10 μ F, 50 V	Garrett Electronics	TPS106K050R0400
C16	Capacitor, 0.7 pF	ATC	100B 0R7
Q1	Transistor	Infineon	BCP56
QQ1	Voltage regulator	National Semiconductor	LM7805
R1	Chip resistor, 1.2 k-ohms	Digi-Key	P1.2KGCT-ND
R2	Chip resistor, 1.3 k-ohms	Digi-Key	P1.3KGCT-ND
R3	Chip resistor, 2 k-ohms	Digi-Key	P2KECT-ND
R4	Potentiometer, 2 k-ohms	Digi-Key	3224W-202ETR-ND
R5	Chip resistor, 10 ohms	Digi-Key	P10ECT-ND
R6, R7	Chip resistor, 5.1 k-ohms	Digi-Key	P5.1KECT-ND
R8	Chip resistor, 1 k-ohms	Digi-Key	P1.0KGCT-ND
R9	Chip resistor, 10 k-ohms	Digi-Key	P10GCT-ND

*Gerber Files for this circuit available on request

Package Outline Specifications

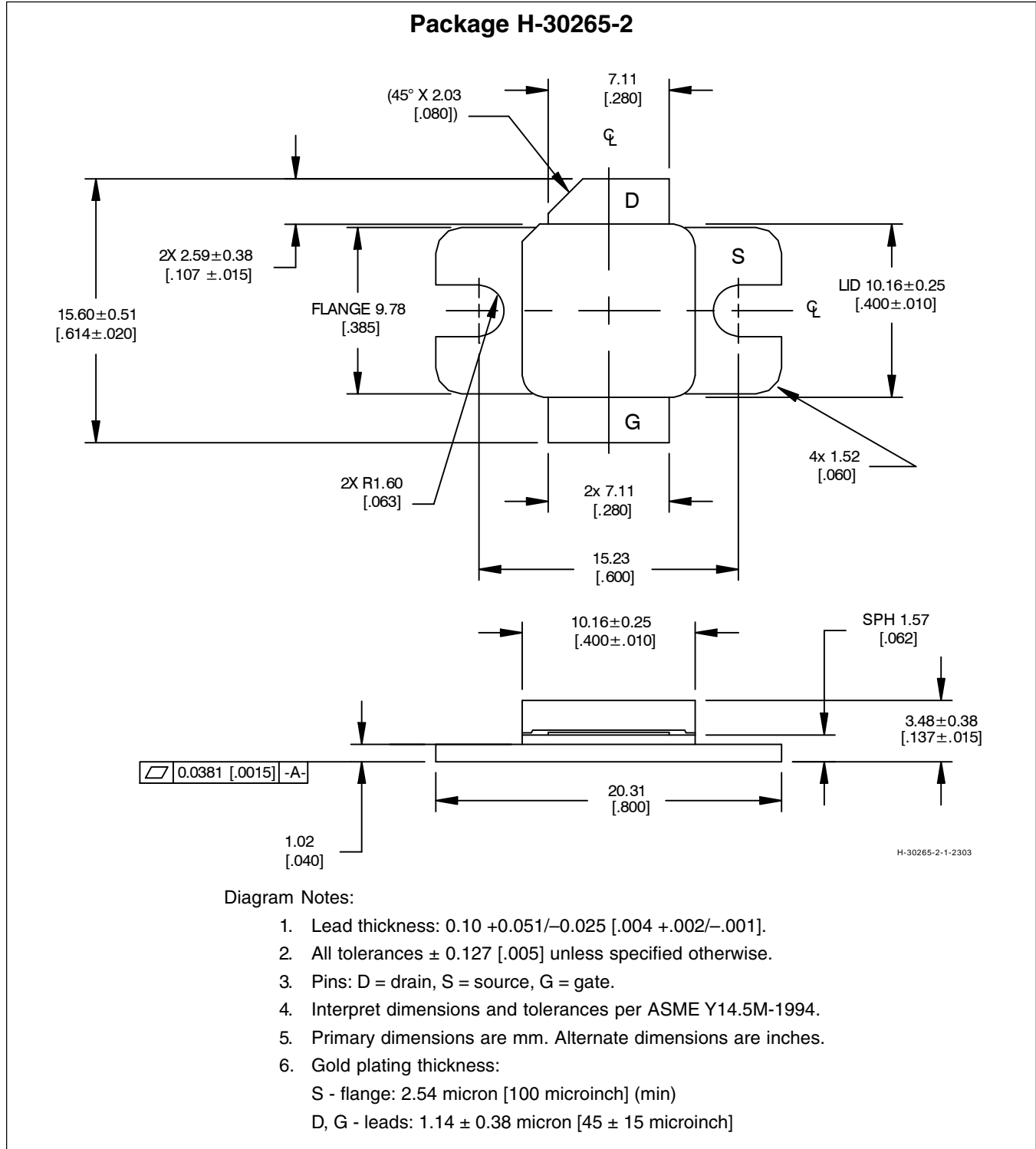

Find the latest and most complete information about products and packaging at the Infineon Internet page
<http://www.infineon.com/rfpower>

Revision History: 2008-03-04

Data Sheet

Previous Version: 2005-06-22, Data Sheet, Rev. 02

Page	Subjects (major changes since last revision)
All	Remove references to alternate products.

We Listen to Your Comments

Any information within this document that you feel is wrong, unclear or missing at all?

Your feedback will help us to continuously improve the quality of this document.

Please send your proposal (including a reference to this document) to:

highpowerRF@infineon.com

To request other information, contact us at:
+1 877 465 3667 (1-877-GO LDMOS) USA
or +1 408 776 0600 International

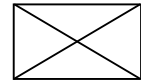

GOLDMOS[®] is a registered trademark of Infineon Technologies AG.

Edition 2008-03-04

**Published by Infineon Technologies AG,
St.-Martin-Strasse 53,
81669 München, Germany**

**© Infineon Technologies AG 2004.
All Rights Reserved.**

Attention please!

The information herein is given to describe certain components and shall not be considered as a guarantee of characteristics.

Terms of delivery and rights to technical change reserved.

We hereby disclaim any and all warranties, including but not limited to warranties of non-infringement, regarding circuits, descriptions and charts stated herein.

Information

For further information on technology, delivery terms and conditions and prices please contact your nearest Infineon Technologies Office (www.infineon.com/rfpower).

Warnings

Due to technical requirements components may contain dangerous substances. For information on the types in question please contact your nearest Infineon Technologies Office.

Infineon Technologies Components may only be used in life-support devices or systems with the express written approval of Infineon Technologies, if a failure of such components can reasonably be expected to cause the failure of that life-support device or system, or to affect the safety or effectiveness of that device or system. Life support devices or systems are intended to be implanted in the human body, or to support and/or maintain and sustain and/or protect human life. If they fail, it is reasonable to assume that the health of the user or other persons may be endangered.